

Eee PC User Manual

Eee PC 900AX

ASUS is devoted to creating environment-friendly products/packagings to safeguard consumers' health while minimizing the impact on the environment. In order to reduce the use of substances harmful to the environment, the Eee PC™ product package does not come with the Eee PC™ support DVD. The reduction of the number of the manual pages complies with the reduction of carbon emission. For system recovery, refer to the section Using Recovery Partition for the instruction on the F9 recovery.

For the detailed user manual and related information, visit the ASUS Support Site at <http://support.asus.com/>

Notes for This Manual

A few notes and warnings are used throughout this guide, allowing you to complete certain tasks safely and effectively. These notes have different degrees of importance as follows:



WARNING! Important information that must be followed for safe operation.



IMPORTANT! Vital information that must be followed to prevent damage to data, components, or persons.



TIP: Tips for completing tasks.



NOTE: Information for special situations.

Transportation Precautions

To prepare your Eee PC for transport, you should turn it OFF and **disconnect all external peripherals to prevent damage to the connectors**. The hard disk drive's head retracts when the power is turned OFF to prevent scratching of the hard disk surface during transport. **Therefore, you should not transport your Eee PC while the power is still ON.** Close the display panel to protect the keyboard and display panel.

The Eee PC's surface is easily dulled if not properly cared for. Be careful not to rub or scrape surfaces when transporting your Eee PC. You can put your Eee PC in a carrying case for protection from dirt, water, shock, and scratches.

Charging Your Batteries

If you intend to use battery power, be sure to fully charge your battery pack before going on long trips. Remember that the power adapter charges the battery pack as long as it is plugged into the computer and an AC power source. Be aware that it takes much longer to charge the battery pack when the Eee PC is in use.

Remember to fully charge the battery (8 hours or more) before first use and whenever it is depleted to prolong battery life. The battery reaches its maximum capacity after a few full charging and discharging cycles.

Airplane Precautions

Contact your airline if you want to use the Eee PC on the airplane. Most airlines have restrictions for using electronic devices. Most airlines allow electronic use only between and not during takeoffs and landings.



There are three main types of airport security devices: X-ray machines (used on items placed on conveyor belts), magnetic detectors (used on people walking through security checks), and magnetic wands (hand-held devices used on people or individual items). You can send your Eee PC and diskettes through airport X-ray machines. However, it is recommended that you do not send your Eee PC or diskettes through airport magnetic detectors or expose them to magnetic wands.

Top Side

Refer to the diagram below to identify the components on this side of the Eee PC.



The top side may vary in appearance depending on models.

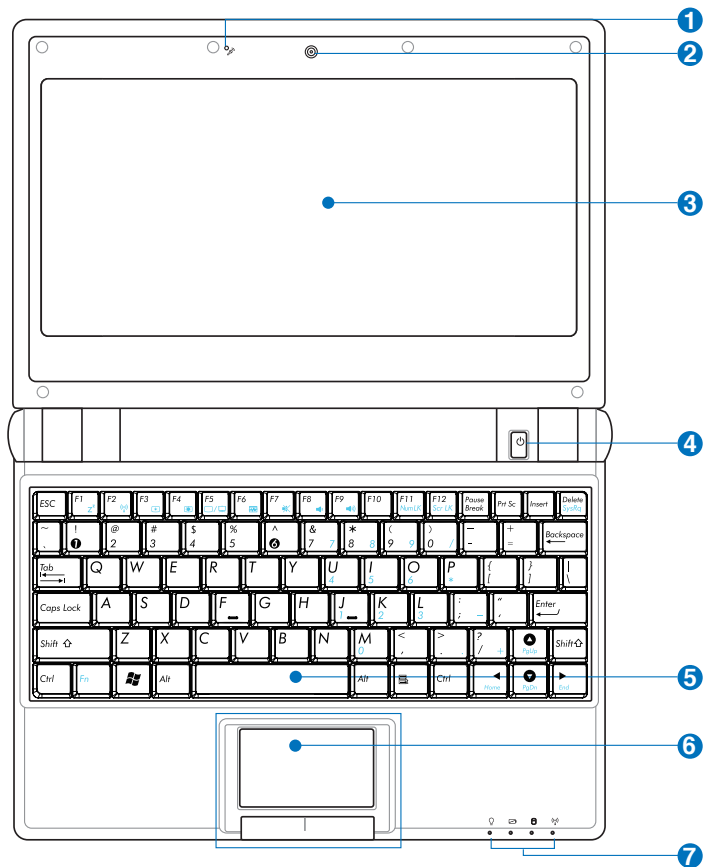

The keyboard differs for each territory.



Microphone (Built-in)



Built-in Camera (on selected models)



Display Panel



Power Switch

The power switch allows powering ON and OFF the Eee PC and recovering from STR. Press the switch once to turn ON and hold it to turn OFF the Eee PC. The power switch only works when the display panel is opened.



Keyboard

The keyboard provides keys with comfortable travel (depth at which the keys can be depressed) and palm rest for both hands.



Touchpad and Buttons

The touchpad and its buttons comprises a pointing device that provides the same functions as a desktop mouse.



Status Indicators

Power Indicator

The power indicator lights when the Eee PC is turned ON and blinks slowly when the Eee PC is in the Save-to-RAM (Suspend) mode. This indicator is OFF when the Eee PC is turned OFF.

Battery Charge Indicator

The battery charge indicator (LED) shows the battery charging status as follows:

Powered ON

	With Adapter	Without Adapter
High battery power (95%–100%)	Green ON	Off
Medium battery power (11%–94%)	Orange ON	Off
Low battery power (0%–10%)	Orange Blinking	Orange Blinking

Powered OFF / Standby mode

	With Adapter	Without Adapter
High battery power (95%–100%)	Green ON	Off
Medium battery power (11%–94%)	Orange ON	Off
Low battery power (0%–10%)	Orange Blinking	Off



Hard Disk Drive (HDD) Indicator

The hard disk drive indicator blinks when data is written to or read from the disk drive.



Wireless/Bluetooth Indicator

This is only applicable on models with built-in wireless LAN/Bluetooth (on selected models). When the built-in wireless LAN/Bluetooth is enabled, this indicator lights.

Bottom Side

Refer to the diagram below to identify the components on this side of the Eee PC.



The bottom side may vary in appearance depending on model.

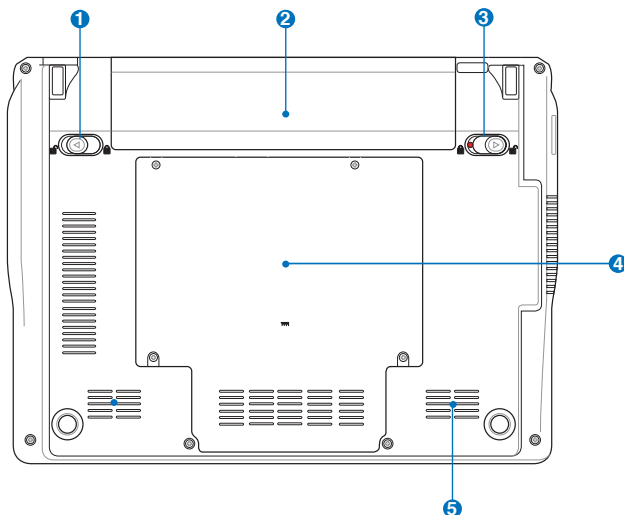





The bottom of the Eee PC can get very hot. Be careful when handling the Eee PC while it is in operation or recently been in operation. High temperatures are normal during charging or operation. **DO NOT USE ON SOFT SURFACES SUCH AS SOFAS OR BEDS, WHICH MAY BLOCK THE VENTS. DO NOT PUT THE Eee PC ON YOUR LAP OR OTHER PARTS OF THE BODY TO AVOID INJURY FROM THE HEAT.**



Battery Lock - Spring





The spring battery lock keeps the battery pack secure. When the battery pack is inserted, it will automatically lock. When removing the battery pack, this spring lock must be retained in the unlocked position.

- 2**  **Battery Pack**
Battery time varies by usage and by the specifications for this Eee PC. The battery pack cannot be disassembled and must be purchased as a single unit.
- 3**  **Battery Lock - Manual**
The manual battery lock is used to keep the battery pack secured. Move the manual lock to the unlocked position to insert or remove the battery pack. Move the manual lock to the locked position after inserting the battery pack.
- 4**  **Memory Compartment**
The memory module is secured in a dedicated compartment.
- 5**  **Audio Speaker System**
Audio features are software controlled.

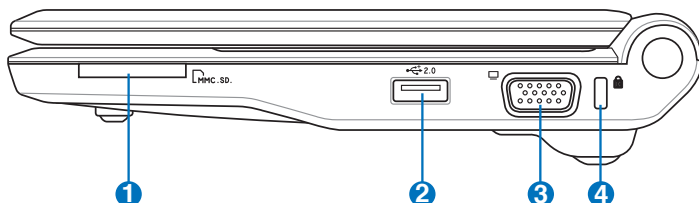
Right Side

Refer to the diagram below to identify the components on this side of the Eee PC.



- 1**  **Memory Card Slot**
The built-in memory card reader can read SD/SDHC/MMC cards.
- 2**  **USB Port (2.0/1.1)**
- 3**  **15 pin D-Sub Display (Monitor) Output**
- 4**  **Kensington® Lock port**
The Kensington® lock port allows the Eee PC to be secured using Kensington® compatible security products. These security products usually include a metal cable and lock that prevent the Eee PC to be removed from a fixed object.

Left Side

Refer to the diagram below to identify the components on this side of the Eee PC.

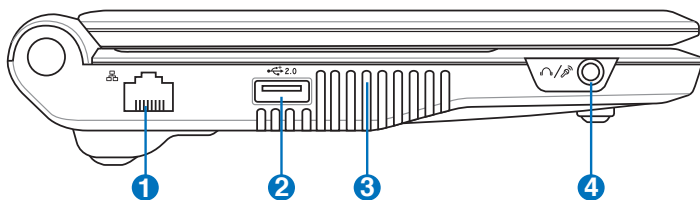

1 LAN Port

The eight-pin RJ-45 LAN port (10/100M bit) supports a standard Ethernet cable for connection to a local network.

2 USB Port (2.0/1.1)

3 Air Vents

The air vents allow cool air to enter and warm air to exit the Eee PC.



Ensure that paper, books, clothing, cables, or other objects do not block any of the air vents or else overheating may occur.

4 Headphone Output & Microphone Input Combo Jack

This combo jack (1/8 inch) can be used to connect the Notebook PC's audio out signal to amplified speakers or headphones, or can be used to connect an external microphone or output signals from audio devices. Select the connecting device type in the dialog box and switches the jack function.

Rear Side

Refer to the diagram below to identify the components on this side of the Eee PC.

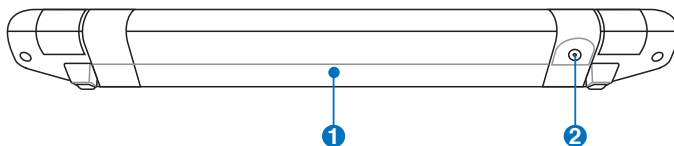

1 **Battery Pack**

Battery time varies by usage and by the specifications for this Eee PC. The battery pack cannot be disassembled and must be purchased as a single unit.

2 **Power (DC) Input**

The supplied power adapter converts AC power to DC power for use with this jack. Power supplied through this jack supplies power to the Eee PC and charges the internal battery pack. To prevent damage to the Eee PC and battery pack, always use the supplied power adapter.



THE ADAPTER MAY BECOME WARM TO HOT WHEN IN USE. BE SURE NOT TO COVER THE ADAPTER AND KEEP IT AWAY FROM YOUR BODY.

Keyboard Usage

Special Function Keys

The following defines the colored hot keys on the Eee PC's keyboard. The colored commands can only be accessed by first pressing and holding the function key while pressing a key with a colored command. Some function icons appear in the Notification area after activation.



The Hot Key locations on the function keys may vary depending on model but the functions should remain the same. Follow the icons whenever your hot key locations do not match the manual.



zzZ Icon (F1): Places the Eee PC in suspend mode (Save-to-RAM).



Radio Tower (F2): Wireless Models Only: Toggles the internal wireless LAN ON or OFF with an on-screen-display. When enabled, the corresponding wireless indicator will light.



Sun Down Icon (F3): Decreases the display brightness.



Sun Up Icon (F4): Increases the display brightness.



LCD/Monitor Icons (F5): Toggles between the Eee PC's LCD display and an external monitor in this series: LCD Only -> CRT Only (External Monitor) -> LCD + CRT Clone -> LCD + CRT Extend.



Task Manager Icon (F6): Initiates the Task Manager to view the application process or terminates applications.



Crossed Speaker Icon (F7): Mutes the speaker.



Speaker Down Icon (F8): Decreases speaker volume.



Speaker Up Icon (F9): Increases the speaker volume.



Num Lk (F11): Toggles the numeric keypad (number lock) ON and OFF. Allows use of a larger portion of the keyboard for number entering.



Scr Lk (F12): Toggles the “Scroll Lock” ON and OFF. Allows you to use a larger portion of the keyboard for cell navigation.



Prt Sc (Ins): Toggles the “Print Screen” key to capture the contents of entire desktop.



Pg Up (↑): Press to scroll up in documents or the web browser.



Pg Dn (↓): Press to scroll down in documents or the web browser.



Home (←): Press to move the pointer to the beginning of the line.



End (→): Press to move the pointer to the end of the line.



Windows icon: Displays the start menu.



Menu with pointer icon : Activates the properties menu and is equivalent to right-clicking the touchpad/mouse on an object.

Touchpad Usage

Multi-finger gesture input (on selected models)

Two-finger zooming in/out - Moving two fingertips apart or together on the touchpad to zoom in or zoom out. This is convenient when viewing photos or reading documents.

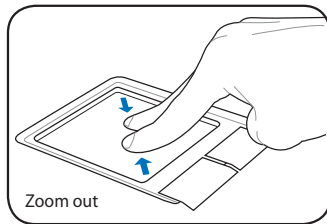
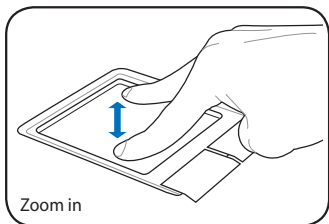

Two-finger rotating - Fix one fingertip on the touchpad and make an arc with the other to rotate the photo or the document you are viewing. You can make a clockwise or counterclockwise rotation based on your needs.

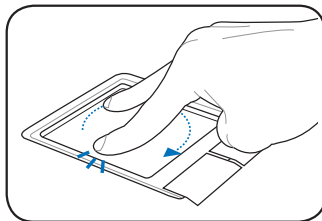

Two-finger scrolling up/down or left/right - Use two fingertips to slide up/down or left/right on the touchpad to scroll a window up/down or left/right. If your display window includes several sub-windows, move the pointer on that pane before scrolling.

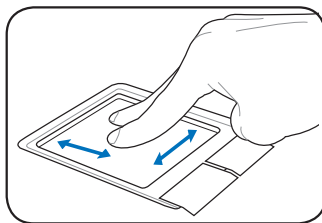

Three-finger page up/down - Use three fingers to move horizontally on the touchpad to swipe pages. Swipe from left to the right to view the next page or right to the left to return to the previous pages.

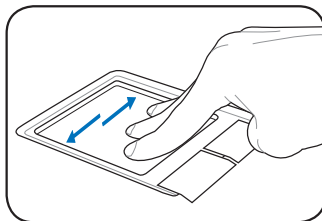

Powering on your Eee PC

These are only quick instructions for using your Eee PC.

1. Install the battery pack

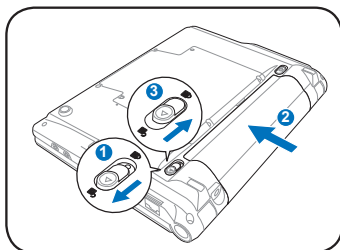

2. Connect the AC power adapter

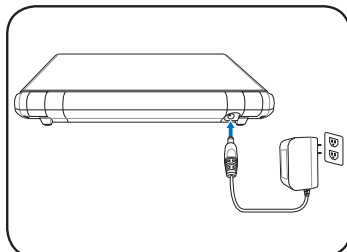

3. Turn ON the Eee PC

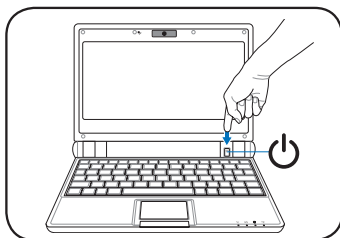

Damage may occur if you use a different adapter to power the Eee PC. You may damage both your battery pack(s) and the Eee PC with a faulty AC-DC adapter.



- When you open the display panel, do not force it down to the table or else the hinges may break! Never lift the Eee PC by the display panel!
- Only use battery packs and power adapters supplied with this Eee PC or specifically approved by the manufacturer or retailer for use with this model or else damage may occur to the Eee PC. The output voltage of this adapter is +9.5V, 2.5A, 24W.
- Never attempt to remove the battery pack while the Eee PC is turned ON, as this may result in the loss of working data.





Remember to fully charge the battery before first use and whenever it is depleted to prolong battery life.

Network Connection

Configuring a wireless network connection

1. Double-click the crossed wireless network icon  in the Notification area.



If the wireless connection icon does not show in the Notification area. Activate the wireless LAN function by pressing  +  (<Fn> + <F2>) before configuring a wireless network connection.



2. Select the wireless access point you want to connect to from the list and click **Connect** to build the connection.



If you cannot find the desired access point, click **Refresh network list** in the left pane and search in the list again.

3. When connecting, you may have to enter a password.
4. After a connection has been established, the connection is shown on the list.
5. You can see the wireless network icon  in the Notification area.



The wireless connection icon disappears when you Press  +  (<Fn> + <F2>) to disable the WLAN function.

System Recovery



Disable **Boot Booster** in BIOS setup before you perform system recovery from USB flash disk, external optical drive or hidden partition.

Using Recovery Partition (F9 Recovery)

About the Recovery Partition

The Recovery Partition is a space reserved on your hard disk drive used to restore the operating system, drivers, and utilities installed on your Eee PC at the factory.



Ensure to connect your Eee PC to the AC power adapter before using F9 recovery to avoid recovery failure.

Using the Recovery Partition:



Ensure to press <F9> only once during bootup.

1. Press <F9> during bootup (requires a Recovery Partition)
2. Click **Recovery** in the **Recovery System** dialog box to start the system recovery.
3. The system starts system recovery automatically and follow the onscreen instructions to complete the recovery process.

Boot Booster

The Boot Booster item in BIOS setup helps shorten your Eee PC bootup time. However, you **MUST** disable this BIOS item before you change any Eee PC components or perform system recovery (from USB flash disk, external optical drive or hidden partition). Follow the instructions below to disable Boot Booster:

1. Start the system and press **<F2>** on bootup to show the POST screen. Press **<F2>** again to enter the BIOS setup.
2. Set **Boot Booster** to [Disabled].



If you fail to see the POST screen or enter the BIOS setup by doing the instruction above, restart the system and try pressing **<F2>** repeatedly on bootup.

3. Press **<F10>** to save the configuration and restart Eee PC.



Remember to enable Boot Booster after you complete hardware change or system recovery.

Declarations and Safety Statements

CE Mark Warning



CE marking for devices without wireless LAN/Bluetooth

The shipped version of this device complies with the requirements of the EEC directives 2004/108/EC “Electromagnetic compatibility” and 2006/95/EC “Low voltage directive.”



CE marking for devices with wireless LAN/Bluetooth

This equipment complies with the requirements of Directive 1999/5/EC of the European Parliament and Commission from 9 March, 1999 governing Radio and Telecommunications Equipment and mutual recognition of conformity.

Power Safety Requirement

Products with electrical current ratings up to 6A and weighing more than 3Kg must use approved power cords greater than or equal to: H05VV-F, 3G, 0.75mm² or H05VV-F, 2G, 0.75mm².



Risk of Explosion if Battery is Replaced by an Incorrect Type. Dispose of Used Batteries According to the Instructions.



DO NOT throw the battery in municipal waste. The symbol of the crossed out wheeled bin indicates that the battery should not be placed in municipal waste.



DO NOT throw the Eee PC in municipal waste. This product has been designed to enable proper reuse of parts and recycling. The symbol of the crossed out wheeled bin indicates that the product (electrical, electronic equipment and mercury-containing button cell battery) should not be placed in municipal waste. Check local regulations for disposal of electronic products.



SAFE TEMP: This Eee PC should only be used in environments with ambient temperatures between 5°C (41°F) and 35°C (95°F).

Copyright Information

No part of this manual, including the products and software described in it, may be reproduced, transmitted, transcribed, stored in a retrieval system, or translated into any language in any form or by any means, except documentation kept by the purchaser for backup purposes, without the express written permission of ASUSTeK COMPUTER INC. ("ASUS").

ASUS and Eee PC logo are trademarks of ASUSTek Computer Inc. Information in this document is subject to change without notice.
Copyright © 2010 ASUSTeK COMPUTER INC. All Rights Reserved.

Limitation of Liability

Circumstances may arise where because of a default on ASUS' part or other liability, you are entitled to recover damages from ASUS. In each such instance, regardless of the basis on which you are entitled to claim damages from ASUS, ASUS is liable for no more than damages for bodily injury (including death) and damage to real property and tangible personal property; or any other actual and direct damages resulted from omission or failure of performing legal duties under this Warranty Statement, up to the listed contract price of each product.

ASUS will only be responsible for or indemnify you for loss, damages or claims based in contract, tort or infringement under this Warranty Statement.

This limit also applies to ASUS' suppliers and its reseller. It is the maximum for which ASUS, its suppliers, and your reseller are collectively responsible.

UNDER NO CIRCUMSTANCES IS ASUS LIABLE FOR ANY OF THE FOLLOWING: (1) THIRD-PARTY CLAIMS AGAINST YOU FOR DAMAGES; (2) LOSS OF, OR DAMAGE TO, YOUR RECORDS OR DATA; OR (3) SPECIAL, INCIDENTAL, OR INDIRECT DAMAGES OR FOR ANY ECONOMIC CONSEQUENTIAL DAMAGES (INCLUDING LOST PROFITS OR SAVINGS), EVEN IF ASUS, ITS SUPPLIERS OR YOUR RESELLER IS INFORMED OF THEIR POSSIBILITY.

Manufacturer	ASUSTek COMPUTER INC.
Address, City	No. 150, LI-TE RD., PEITOU, TAIPEI 112, TAIWAN R.O.C
Country	TAIWAN
Authorized Representative in Europe	ASUS COMPUTER GmbH
Address, City	HARKORT STR. 21-23, 40880 RATINGEN
Country	GERMANY

